

GRU A TORRE

GA 727 | 2500

GRU AUTOMATICA CON
MONTAGGIO IDRAULICO

GA compact



GX



GHS topless



FBGRU

LIFT YOUR GOALS!

FB F.lli Butti s.r.l.

Via XXV Aprile, 58

23868 Valmadrera (LC) - Italia

Tel. 0341.581108 - Fax 0341.200253

E-mail : fbgru@fbgru.it - <http://www.fbgru.it>

CE

FEM 1.001 - A3
EN 14439 - C25

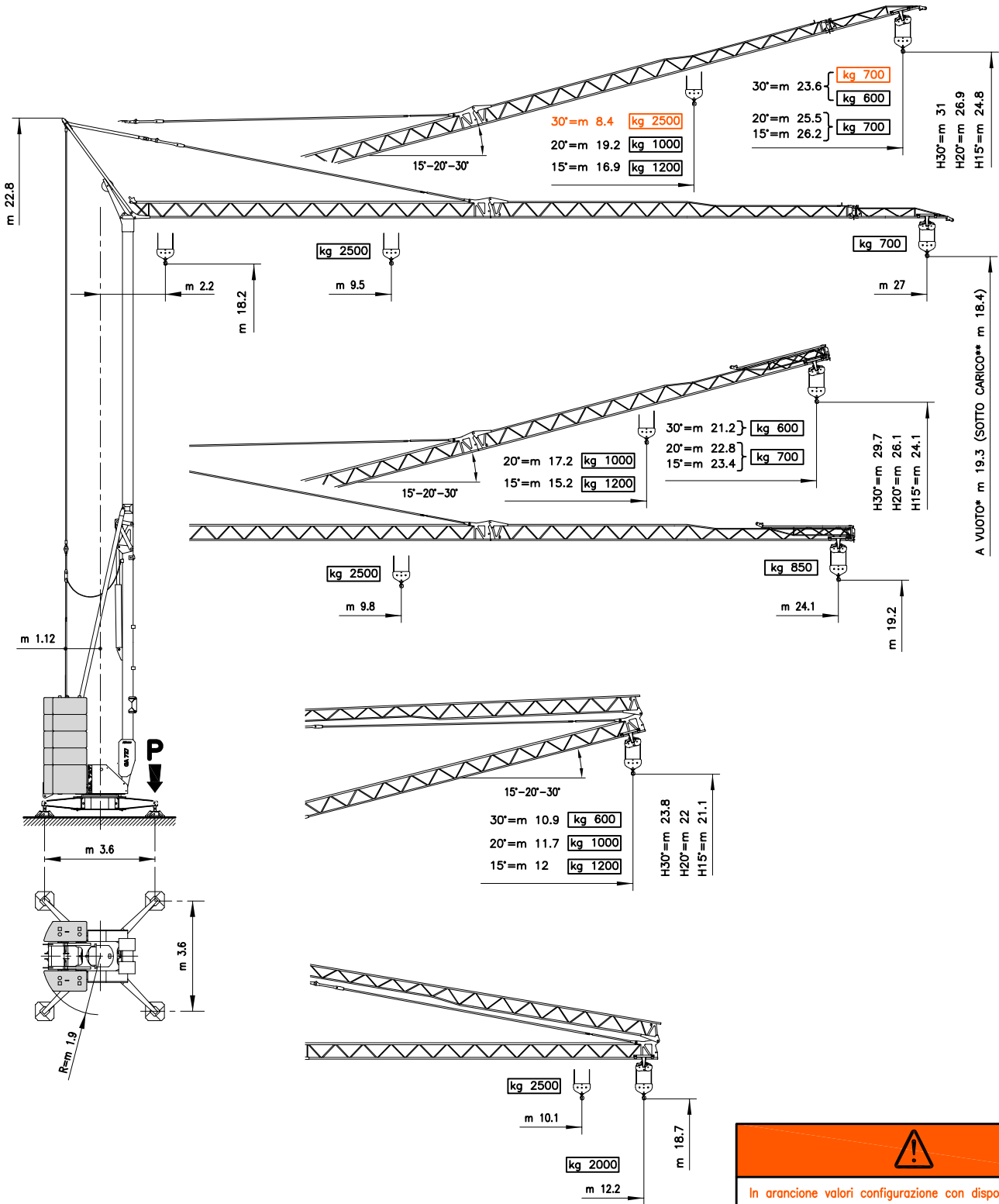

* SIN CARGA OFF-LOAD UNBELASTET A VIDE
 ** CARGADO LOADED BELASTET EN CHARGE

 In arancione valori configurazione con dispositivo per 30°
 En valores de configuracion naranja con dispositivo para 30°
 In orange, configuration values with device for 30°
 In orange, Konfigurationswerte mit Einrichtung für 30°
 En rouge le valeurs de configuration avec dispositif pour 30°

P	
kg 15900	kg 13150
<i>In servizio</i>	<i>Fuori servizio</i>
En servicio	Fuera de servicio
In service	Out of service
In betrieb	Außer betrieb
En service	Hors service

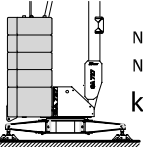
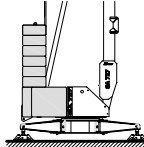
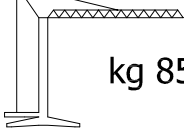
		
 A N° 8x1519 N° 2x2620 kg 25902	 B N° 6x1500 N° 2x2620 kg 22750	 kg 8510

MOVIMENTO MOVIMIENTO MOVEMENT BEWEGUNG MOUVEMENT	ALIMENTAZIONE ALIMENTACION OPERATING VOLTAGE BETRIEBSSPANNUNG TENSION DE SERVICE	PRESTAZIONI FUNCIONAMIENTOS PERFORMANCES LEISTUNGEN EXÉCUTIONS	
---	---	---	--

SOLLEVAMENTO ELEVACION – HOISTING HEBEN – LEVAGE INVERTER	230 V 50 Hz	3 kW	1 ^a m/1' - kg 3.2 ↑ 6 ↓ 2500	2 ^a m/1' - kg 8 ↑ 11 ↓ 2500	3 ^a m/1' - kg 19 ↑ 20 ↓ 700	kW 9.2	
		6 kW	3.2 ↑ 6 ↓ 2500	8 ↑ 11 ↓ 2500	30 ↑ 32 ↓ 700		
	400 V 50 Hz	3.2 ↑ 6 ↓ 2500		21 ↑ 25 ↓ 2500	39 ↑ 42 ↓ 700		46 ↑ 50 ↓ 600

CARRELLO CARRILLO – JIB TROLLEY LAUFKATZE – DISTRIBUTION INVERTER	230 - 400 V 50 Hz	1 ^a m/1'	2 ^a m/1'	3 ^a m/1'	kW 2.2
		15	23	41	

ROTAZIONE ROTACION – SLEWING DREHEN – ORIENTATION INVERTER	230 - 400 V 50 Hz	1 ^a g/1'	2 ^a g/1'	3 ^a g/1'	kW 2.2
		0 → 0.19	0.19 → 0.47	0.47 → 0.87	



Conforme alle direttive
CEE sul livello acustico
2000/14/CE

Conforme con las directivas
CEE sobre el nivel acustico

In compliance with the EEC
instructions on noise levell

Gemass EWG-Richtlinien für
den Schall-Leistungspegel

Conforme aux directives CEE
sur le niveau acoustique

CURVE DI CARICO

CURVAS DE CARGAS – LOAD DIAGRAMS LASTKURVEN – COURBES DE CHARGES

V27

 2.5°	m	2.2	5	9.5	11	13	15	17	19	21	23	24.1	25	27
	kg	2500			2085	1707	1438	1237	1082	957	856	808	771	700
 15°	m	2.2	5	8	11	13	15	16.9	19	21	23	24	25	26.2
	kg	1200							1043	923	825	778	743	700
 20°	m	2.2	5	8	11	13	15	17	19.2	21	23	24	25	25.5
	kg	1000								893	797	756	718	700
 30°	m	2.2	5	7	9	11	13	15	17	19	20	21	22	23.6
	kg	600												
 30°	m	2.2	5	7	8.4	11	13	15	17	19	20	21	22	23.6
	kg	2500				1790	1462	1229	1055	919	863	811	765	700

POTENZA RICHIESTA

POTENCIA-ELECTRICA NECESARIA – NECESSARY ELECTRIC POWER KRAFTBEDARF – PUISSANCE ELECTRIQUE NECESSAIRE

	3 kW 230 V - 50 Hz	6 kW 230 V - 50 Hz	12 kW 400 V - 50 Hz

GA 727 - 2500

TRASPORTO TRANSPORTE — TRANSPORT
TRANSPORTE — TRANSPORT

5
km/h

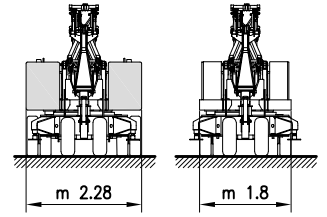
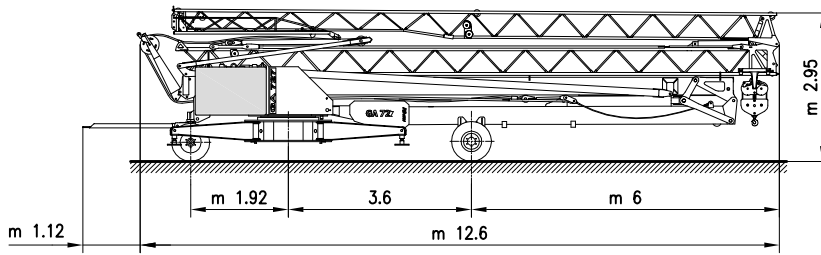

FB25K2

25
km/h

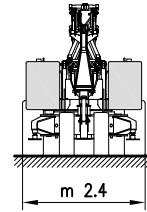
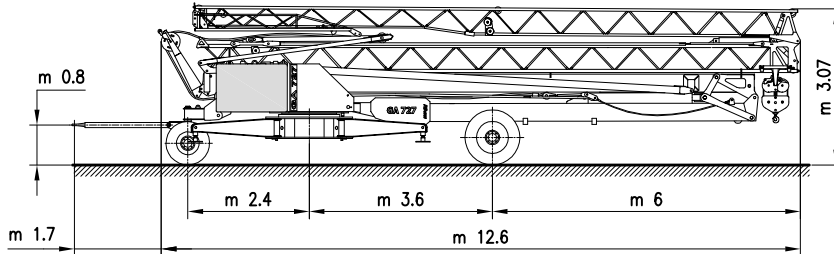

MONTAGGIO MONTAJE — ERECTION
MONTAGE — MONTAGE

